

Signature[®] | LAMINATE





WE'RE PASSIONATE ABOUT WOOD

SWISS KRONO – A STRONG BRAND FAMILY

As a Swiss family company, we develop design solutions for sophisticated living spaces made from natural raw materials – in more than 121 countries, with expertise born from years of experience and outstanding interior and exterior results.



BY SWISS KRONO GROUP



PARTNERSHIP

We work together with you to develop first-class solutions that truly suit your needs. We are always at your side, even after the end of a project. Your trust is what drives us.



SWISS MADE

Our products are developed and manufactured using certified wood from sustainable Swiss forestry. This outstanding quality reflects the high demands we place on ourselves every day in order to provide you with the best possible solution.



RESPONSIBILITY

We are dedicated to a high level of resource efficiency and renewable energy. Our strategy: complete usage of material flows, short distances, renewable energy sources and a high level of energy efficiency.





Collection Index

Liberty | 7

Origin | 13

Noblesse | 19

Swiss Herringbone | 25

Evolution | 9

Solid Chrome | 15

Noblesse Wide | 21

Authentic | 11

Solid | 17

Xpressions | 23



ORIGIN

2025mm

244mm

oversize

AUTHENTIC

1845mm

244mm

oversize

EVOLUTION

1380mm

191mm

LIBERTY

1380mm

191mm



NOBLESSE WIDE



oversize

NOBLESSE



SOLID



SOLID CHROME





KRONOSWISS

AQUASTOP BENEFITS

NALFA SURFACE
SWELL TEST
APPROVED FOR
24 H

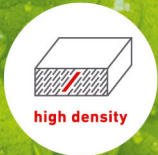

NATURAL
RESOURCES



CHILD & PET
FRIENDLY



WET
MOPPABLE



STEAM
MOPPABLE



The advances in water resistant technology for laminate flooring have been huge. Aquastop ensures water resistance for up to 72 hours, meaning the scope for where you can now use laminate is wider than ever.





SWISS MADE.



All of our Swiss collections are developed and manufactured using certified wood from sustainable forestry. We are also dedicated to maintaining a high level of efficiency and use of renewable energy throughout the manufacturing process.

LIBERTY



D8014
New York Oak



D4491
Santiago Oak



D4658
Castle Oak



D4659
Maple



D4931
Natural Oak Brown



D3784
Lucerne Oak

EVOLUTION

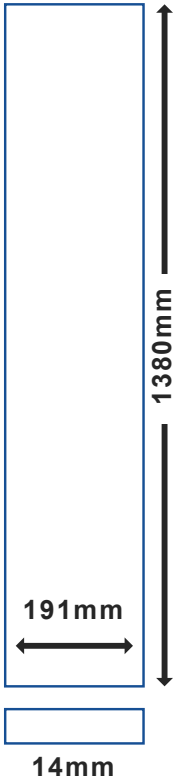

D4508
Ivory Oak



D4510
Graphite Oak



D4511
Pearl Oak



D4512
Copper Oak



D4513
Sandstone Oak



D4515
Gold Oak



D4516
Bronze Oak

AUTHENTIC

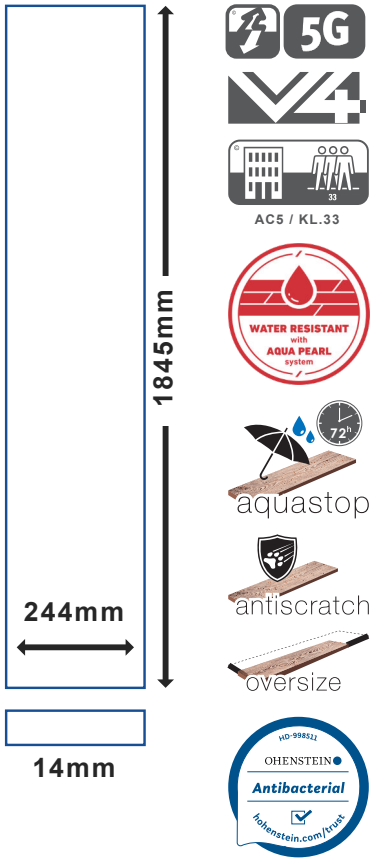



D6106
Natural

ORIGIN

2025mm

244mm

14mm

5G

V4

AC5 / KL.33

WATER RESISTANT
with
AQUA PEARL
system

aquastop

antiscratch

oversize

OHENSTEIN
Antibacterial
ohenstein.com/true





**D4493
Sunset**



**D7093
Forest**



**D7094
Dune**



**D4493
Sunset**

SOLID CHROME

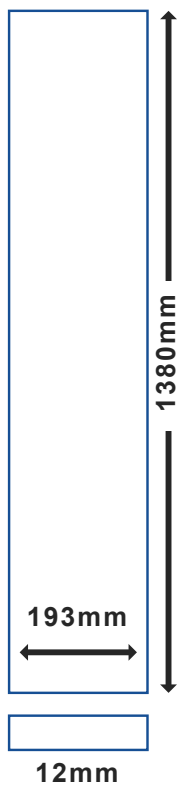

antiscratch





D7092
Gstaad Oak



D4202
Interlaken Oak



D3034
Engelberg Oak



D3035
Davos Oak

SOLID

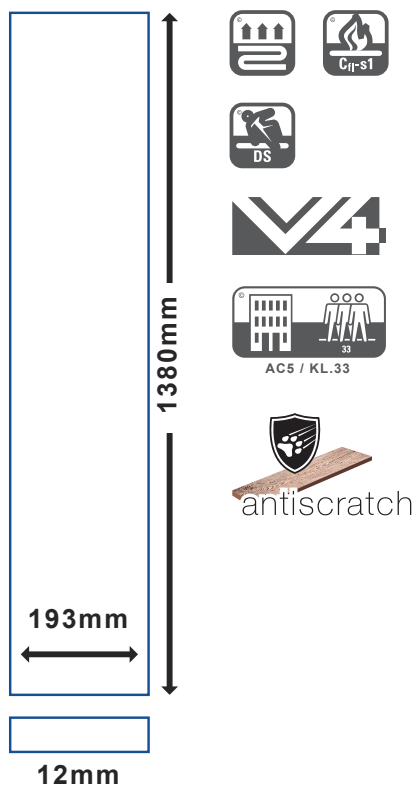



D4940
Minto Pine



D3522
Glasgow Oak



D3569
Gunpowder Grey

NOBLESSE

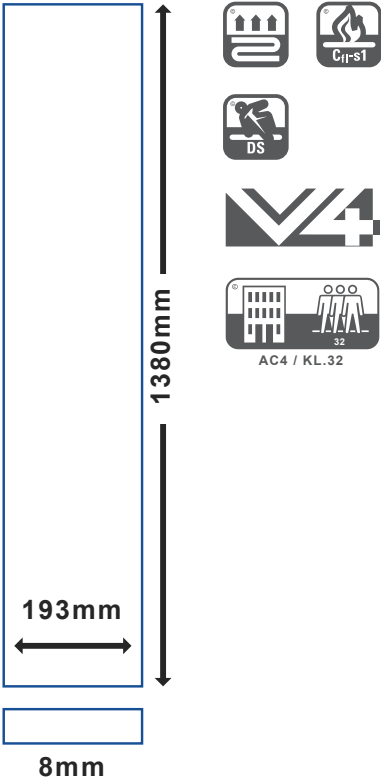



D4545
Urban Oak White



D3522
Glasgow Oak



D6114
Lodge Oak

NOBLESSE WIDE

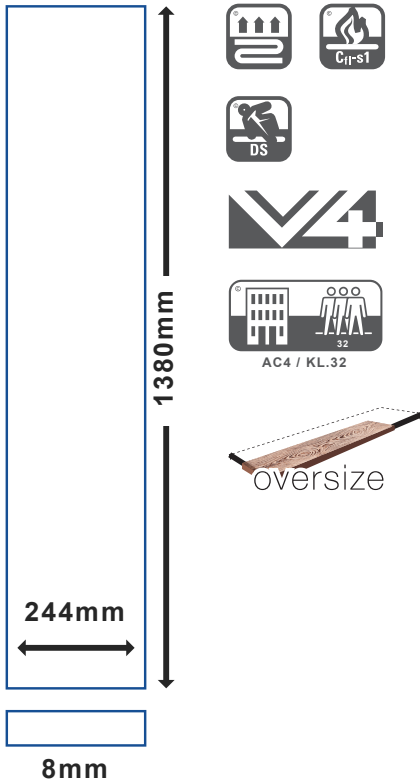

D3569
Gunpowder Grey



D4661
Artisan Oak Grey



D4660
Artisan Oak Natural



LIMITED RESERVE
25 YEARS
P.S.M.

D4662
Artisan Oak Beige

XPRESSIONS HERRINGBONE

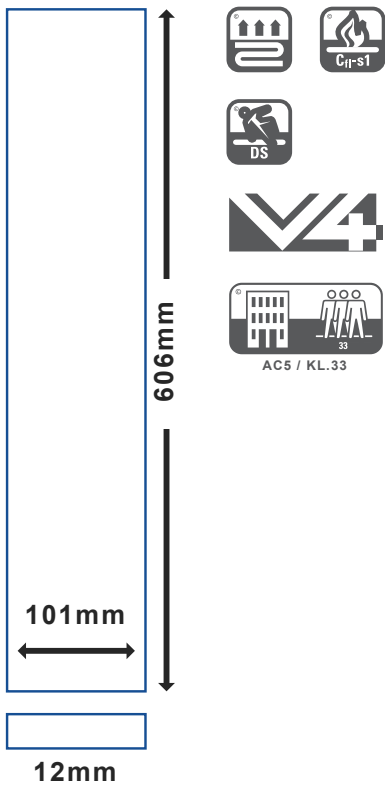

Winchester Oak



Antique Oak Grey



Classic Walnut



Silverwood



Tudor Oak

SWISS HERRINGBONE

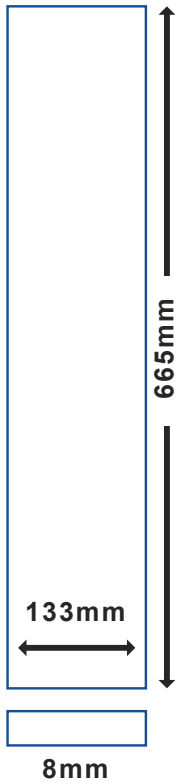

D4169
Alcazar Oak



D4168
Drummon Oak



D3733
Chinon Oak



D4694
Kyburg Oak

Commercial Projects

At Signature Floors we have decades of experience in working on large commercial and residential projects. Working closely with designers and architects on the island of Ireland, we provide a bespoke project planning service to ensure each project exceeds expectations. We regularly provide this service for the following environments:

- Hotels
- Retail
- Residential
- Universities & Colleges
- Healthcare Facilities
- Restaurants

Recent commercial projects of note have included:

- University of Limerick Student Residences
- Cherrywood Apartment Development, Dublin
- Spencer North Apartment Development, Dublin
- Frascati Residential Development, Dublin
- Hansfield Housing Development, Dublin
- Concra Wood Golf Club House, Monaghan
- Stepside Housing Development, Dublin
- Coopers Cross Residential Development, Dublin
- Crows Nest Student Accommodation, Cork
- Westmanstown Golf Club House, Dublin
- Clay Farm Residential Development, Dublin



Cherrywood Apartment Development



University of Limerick Student Residences



Clay Farm Residential Development



Specifications:

Laminate Floor Coverings According to EN 13329

	LIBERTY	EVOLUTION	AUTHENTIC	ORIGIN	SOLID CHROME	SOLID	NOBLESSE	NOBLESSE WIDE	XPRESSIONS HERRINGBONE	SWISS HERRINGBONE
Thickness (mm)	8	14	14	14	12	12	8	8	12	8
Width (mm)	193	191	224	244	193	193	193	244	101	133
Length (mm)	1380	1380	1845	2025	1380	1380	1380	1380	606	665
Level of use	33	33	33	33	33	33	32	32	33	32
Abrasion resistance	AC5	AC5	AC5	AC5	AC5	AC5	AC4	AC4	AC5	AC4
Thickness swelling (%)	≤8	≤10	≤10	≤8	≤15	≤15	≤18	≤18	≤1	≤12
Impact resistance small ball (N)	>15	>15	>15	>15	>15	>15	>12	>12	>8	>12
Impact resistance big ball (mm)	>1000	>1000	>1000	>1000	>1000	>1000	>750	>750	>1000	>750
Warranty domestic/commercial (years)	35 5	35 5	35 5	35 5	30 5	30 5	25 2	25 2	25 2	25 2
Micro-scratch resistance	MSR A2	MSR A3	MSR A3	MSR A3	MSR A2	MSR A2	MSR A3	MSR A3		
Surface soundness (N/mm ²)	1.25	1.25	1.25	1.25	1.25	1.25	1.25	1.25		1.5
Electrostatic Propensity (kV)	≤2	≤2	≤2	≤2	≤2	-	-	-		
Thermal Resistance (m ² k/w)	0.059	0.1	0.1	0.1	0.089	0.089	0.059	0.059	0.099	0.059
Declaration of performance (KCH_LF_005)						✓	✓	✓		
(DOP), antistatic (KCH_LFa_005)	✓	✓	✓	✓	✓					
Effect of furniture leg	No damage									
Castor chair test	No damage									
Resistance to staining	Groups 1 & 2: level 5 Group 3: level 4									
Light-fastness	Blue wool scale 6 Grey Scale ≥ 4									
Reaction to fire	Cfl-s1									
Slip resistance	DS									
VOC emission 28 days (ug/m ³)	100									
Formaldehyde emission (ppm)	≤0.1 (E1)									
Raw HDF board (ppm)	≤0.11 (CARB P2/TSCA TITLE V1)									
Composition	Renewable energy >90% Wood fibres ~80% Swiss Wood UF-Resin ~15%									
Further information	No chlorides No Biocides Heavey-metal free coating Thermally recyclable									

All details were correct at the time this brochure was printed. For the most up-to-date datasheets, please contact us prior to ordering.

Laminate Underlays:

Range Name	ROOMS					Density kg/m ³	Roll Weight	Moisture Barrier	Thickness	Sound Performance Class	Tog	Impact Sound dB
	GB	MB	L/D R	H,S & L	Comm Use							
Acoustica Platinum	✓	✓	✓	✓	✓	707	38.4kg	✓	3.75mm	USR+	0.28	△ LW 23
Acoustica Gold Supreme	✓	✓	✓	✓	✓	350	10.5kg	✓	3.00mm	USR+	0.70	△ LW 22
Acoustica Gold Excel	✓	✓	✓	✓	✓	930	28.0kg	✓	3.50mm	USR+	0.28	△ LW 23
Acoustica Gold	✓	✓	✓	✓	✓	735	21.4kg	✓	3.00mm	PSR+	0.25	△ LW 20
Acoustica Bronze	✓	✓	✓	✓	✓	735	32.2kg		3.00mm	PSR+	0.22	△ LW 22
Acoustica Silver	✓	✓	✓	✓	✓	925	18.5kg	✓	2.00mm	ESR+	0.22	△ LW 22
Acoustica LVT 18dB	✓	✓	✓	✓	✓	1666	25.0kg		1.50mm	ESR+	0.12	△ LW 18
Acoustica Fibreboard	✓	✓	✓	✓	✓				5.00mm	GSR+	0.50	△ LW 22
Whisper Gold	✓	✓	✓	✓	✓	30	1.78kg	✓ +Overlap	5.00mm	PSR+	1.20	△ LW 21
Whisper Guard	✓	✓	✓	✓	✓	65	2.92kg	✓ +Overlap	3.50mm	PSR+	0.88	△ LW 23
Whisper Silver	✓	✓	✓	✓	•	30	1.77kg	✓ +Overlap	3.00mm	GSR+	0.87	△ LW 19
Whisper Green Barrier	✓	✓	✓	✓	•	30	1.93kg	✓ +Overlap	3.00mm	GSR+	0.72	△ LW 19
Whisper 3mm	✓	✓	✓	✓	•	20	0.90kg		3.00mm	BSR	0.70	△ LW 18
Whisper 2mm	✓	✓	✓	✓	•	20	0.60kg		2.00mm	BSR	0.41	△ LW 18

✓ Recommended • Suitable for use in

GB General Bedroom MB Master Bedroom L/D R Lounge Dining Room H,S,L Hall Stairs Landing Comm Commercial Use

Acoustica Underlays

The Floorwise acoustica range of dense rubber underlays are excellent at absorbing noise, both between floors by way of impact sound reduction and within the room through airborne noise reduction.

Whisper Underlays

The range of Whisper PE foam underlays are also very good at absorbing impact noise but do not perform to the same standards as the acoustica range for airborne sound.

Suitability for Underfloor Heating

Floorwise underlays are suitable for use with most underfloor heating systems. The only real exception is a cable matting system, which was developed specifically for use with ceramic and stone floor tiles.

PROVENT™

LET YOUR FLOOR BREATHE

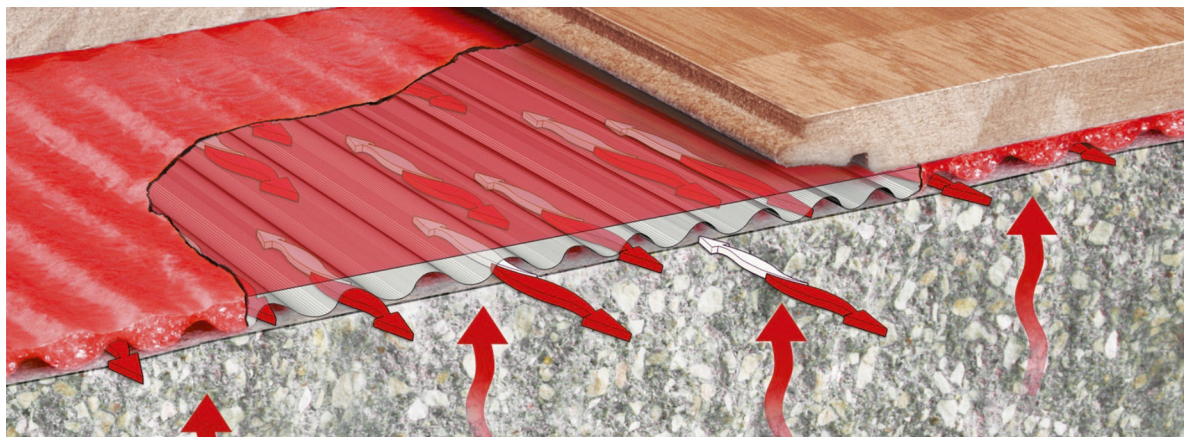
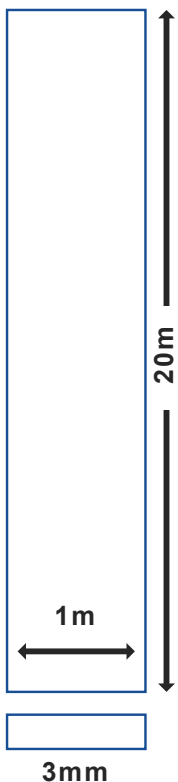

ProVent flooring underlay is an approx. 3 mm thick foam panel made from closed-cell polyethylene. Each panel is coated with a 0.02 mm thick high density polyethylene foil for additional protection against water vapour. The material is particularly resistant to ageing.

ProVent reinforces the ventilation of the concrete under-floor with the help of the patented Micropumping™ (water vapour drainage) system. This ventilation ensures that the water vapour is extracted and the underlay remains dry. As a result, mould is prevented from forming under the flooring.



Stair Profiles

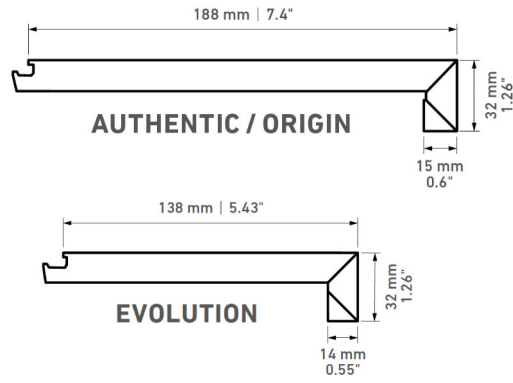

Transition Profile

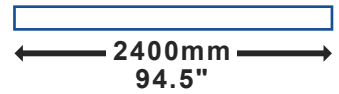
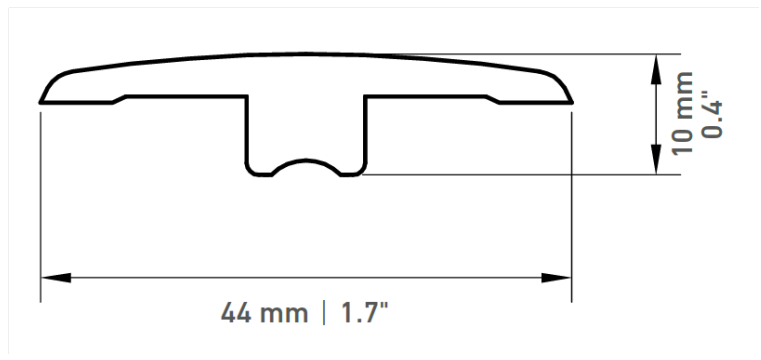

Wooden Skirting

Our skirting is 6" thick, comes in 3.05m lengths, and is available in three colours:

- White
- Natural Oak
- Silver Grey

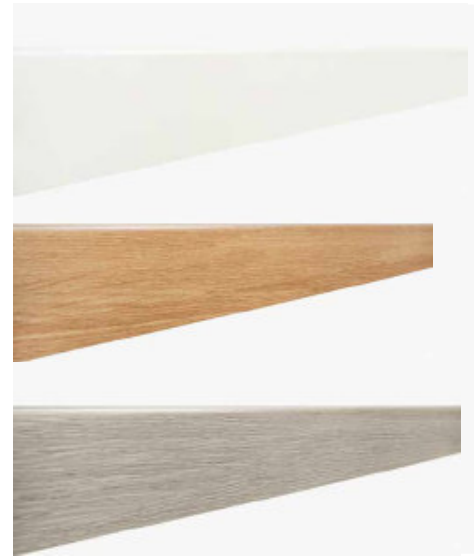

Laminate Cleaner

Ensuring a floor is kept in good condition is important with any floorcovering and a laminate floor is no different. Regular cleaning is an essential part of any maintenance routine and helps to ensure the longevity of your laminate floor. The KronoSwiss floor cleaner is especially formulated for our laminate collections and works gently but thoroughly to help keep your floors in their best condition.

zenith profiles

245 Z Edge Adjustable height up to 9mm

MG

MS



Cat. No: **245MG** Matt Gold
245MS Matt Silver

Profile length
2.7m

This versatile section is used to join carpets with a variety of floor coverings. The top can be adjusted to accommodate surfaces of different heights up to 9mm.

245MG	✓
245MS	✓
Tube size: 15 x 2.7m lengths = 40.5m	

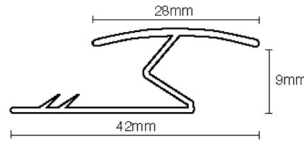

277 Square Edge 8mm

MG

MS



Cat. No: **277MG** Matt Gold
277MS Matt Silver

Profile length
2.7m

Ideal as a capping edge, a finish to open plan areas, or edging to access panels and ceramic floors. To accommodate flooring up to 8.5mm thickness.

277MG	✓
277MS	✓
Tube size: 10 x 2.7m lengths = 27m	

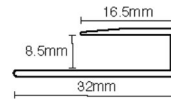

287 Stick Down Edge 9mm

MGA

MSA

OAA

DKWA

GOA



Cat. No: **287MGA** Matt Gold
287MSA Matt Silver
287OAA Oak
287DKWA Dark Walnut
287GOA Grey Oak

Profile length
2.7m

A versatile section which can be used as a capping edge around the room. Also useful around fireplaces and as a finish to open plan areas or as an edge to matwells and access panels.

287MGA	✓
287MSA	✓
287OAA	✓
287DKWA	✓
287GOA	✓
Tube Size: 10 x 2.7m lengths = 27m	

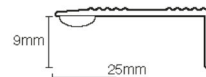

288 Stick Down Edge 15mm

Cat. No: **288MGA** Matt Gold
288MSA Matt Silver

A versatile section which can be used as a capping edge around the room. Also useful around fireplaces and as a finish to open plan areas or as an edge to matwells and Access panels. Suitable for use with wood and thicker laminate floors with underlay.

Profile length
2.7m

288MGA ✓
288MSA ✓

Tube Size: 10 x
2.7m lengths = **27m**

MGA

MSA

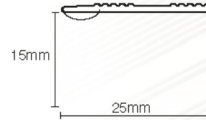

289 Stick Down Sloping Edge 8mm

Cat. No: **289MGA** Matt Gold
289MSA Matt Silver

The Sloping Edge is a transitional profile and protects the edges of floor coverings up to a height of 8mm. With a diminishing sloping edge, the profile provides a ramp down to the adjacent floor covering.

Profile length
2.7m

289MGA ✓
289MSA ✓

Tube Size: 10 x
2.7m lengths = **27m**

MGA

MSA

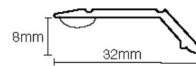

290 Stick Down Sloping Edge 14mm

Cat. No: **290MGA** Matt Gold
290MSA Matt Silver

As **289**, but for use with 14mm wood or laminate on underlay.

Profile length
2.7m

290MGA ✓
290MSA ✓

Tube Size: 10 x
2.7m lengths = **27m**

MGA

MSA

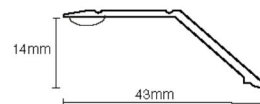

zenith profiles

291 Stick Down Cover Strip 38mm

MGA MSA OAA DKWA GOA



Cat. No: **291MGA** Matt Gold
291MSA Matt Silver
291OAA Oak
291DKWA Dark Walnut
291GOA Grey Oak

The versatile cover strip can be used to conceal and protect joins and expansion gaps between all types of wood, laminate and resilient floor coverings.

Profile length	
	2.7m
291MGA	✓
291MSA	✓
291OAA	✓
291DKWA	✓
291GOA	✓
Tube Size: 10 x	
2.7m lengths = 27m	

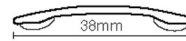

292 Stick Down Sloping Edge 22mm

MSA



Cat. No: **292MSA** Matt Silver

The Sloping Edge is a transitional profile for use with wood flooring or on engineered wood with underlay. With a diminishing sloping edge, the profile provides a ramp down to the adjacent floor covering.

Profile length	
	2.7m
292MSA	✓
Tube Size: 10 x	
2.7m lengths = 27m	

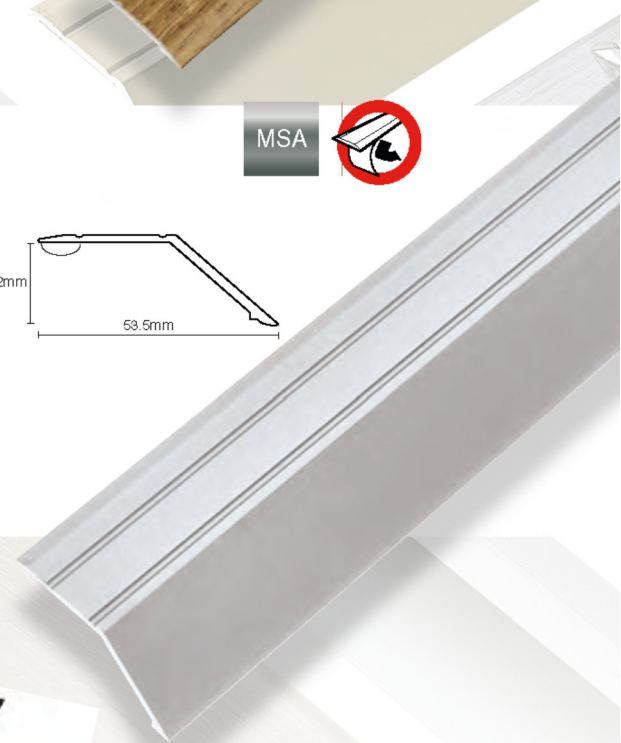
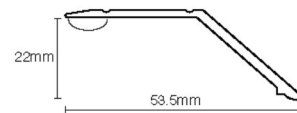

scotia

foil wrapped MDF

Floorwise has developed a quality range of scotia in a wide variety of decors to ensure a professional finish to each and every installation

F541 Scotia

- Used to cover the expansion gap on wood and laminate floors
- Wood foiled
- 16.5mm x 16.5mm x 2.4m

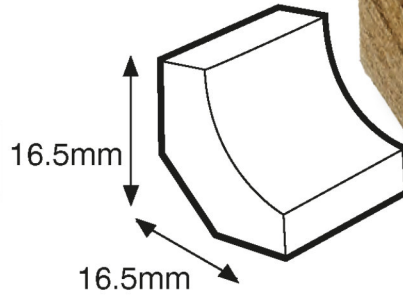

Also available from Signature Floors



Signature® | VINYL



Signature® | GRASS



Signature[®] | CARPET



Signature[®] | CARPET TILES



Signature[®] | LVT



Signature[®] | LAMINATE

www.signaturefloors.ie

2021/22